

Article number: 20194B20V202BL

Description: E+G
T-angel clamps GN194-B20-V20-2-BL

Measures

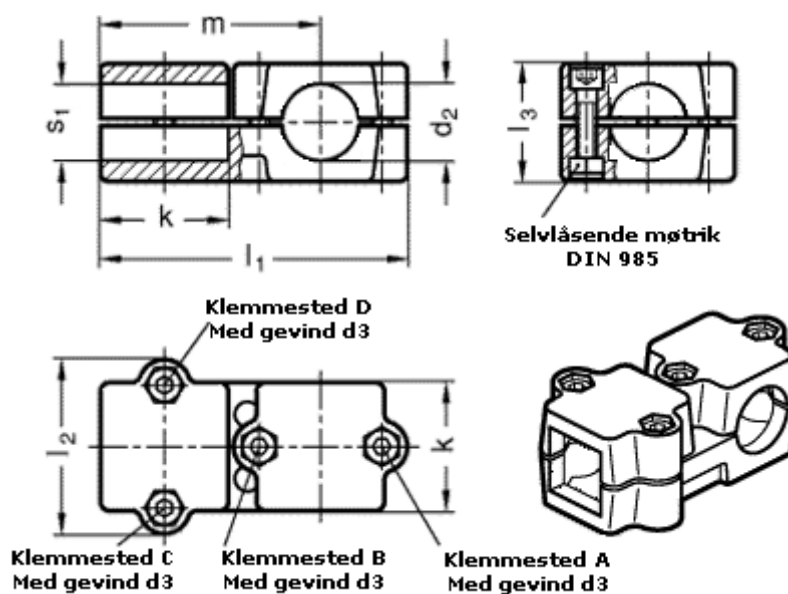

d1 = 20
d3 = M 8
k = 50
l1 = 120
l2 = 68
l3 = 46
m = 85
s2 = 20